



655 EISENHOWER DRIVE  
 OWATONNA, MN 55060 USA  
 PHONE: (507) 455-7000  
 TECH. SERV.: (800) 533-6127  
 FAX: (800) 955-8329  
 ORDER ENTRY: (800) 533-6127  
 FAX: (800) 283-8665  
 INTERNATIONAL SALES: (507) 455-7223  
 FAX: (507) 455-7063

Form No. 553737

**Parts List and  
 Operating Instructions  
 for:**

**5200**

**Service Jack**

Max. Capacity: 2 Tons

*Application: Designed to lift a wide range of motor vehicles.*

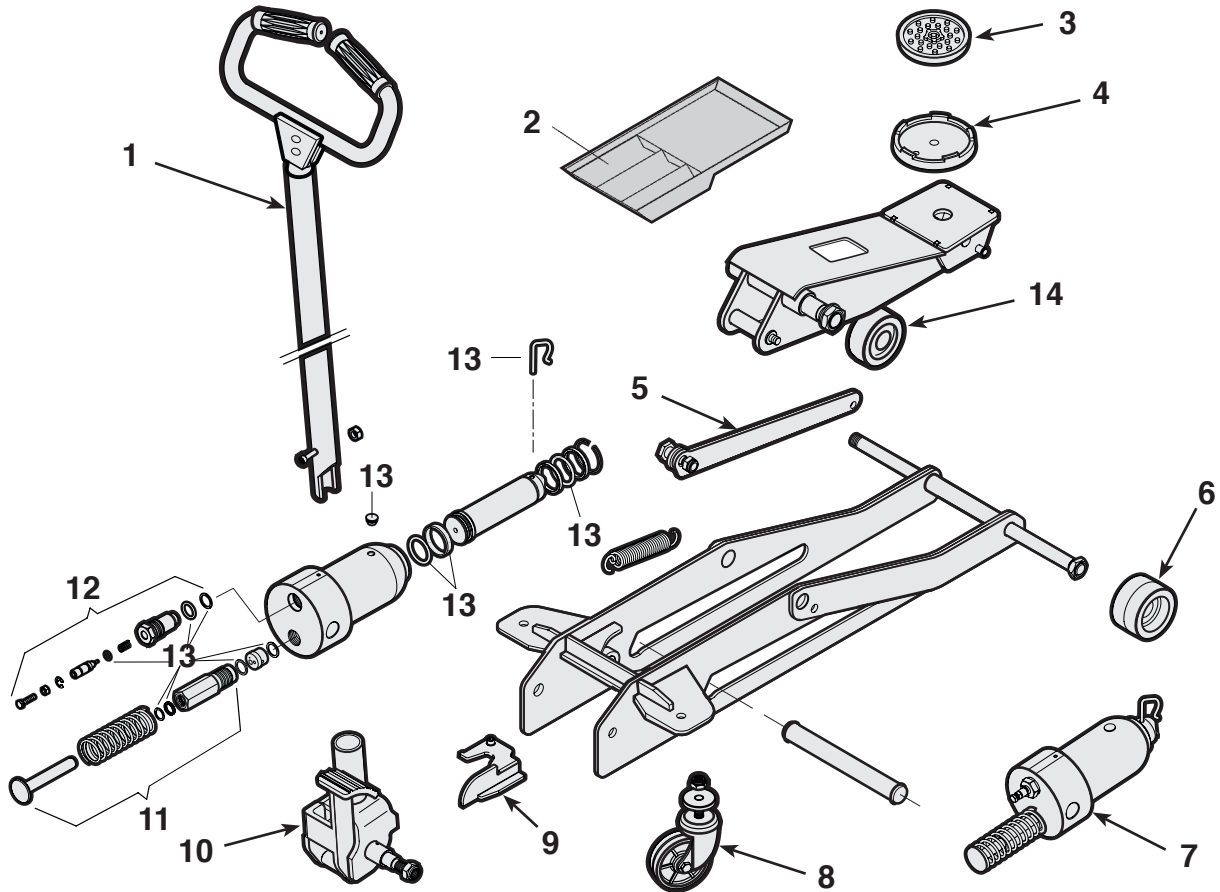

Item No.	Part No.	Qty.	Description
1	541502	1	Handle
2	554979	1	Tray
3	541501	1	Saddle Pad
4	541500	1	Saddle
5	553739	2	Lift Arm Support Strap
6	553740	2	Wheel
7	553741	1	Power Unit
8	541498	2	Caster Kit

Item No.	Part No.	Qty.	Description
9	553742	1	Release Bracket
10	541504	1	Foot Pedal/Handle Mount
11	541507	1	Pump Piston/Cylinder Kit
12	541506	1	Release Valve Stem Kit
13	553743	1	Seal Kit
14	553745	1	Wheel
	553744	1	Hardware Kit

Sheet No. 1 of 2

Issue Date: Rev. C, June 5, 2014

## Bleeding Air from the System

Air can accumulate within a hydraulic system during shipment. This entrapped air causes the jack to respond slowly or feel “spongy.” The following procedure bleeds air from the system.

1. Insert the handle into the handle mount and secure it with the screw provided.
2. Open the release valve by pulling on and turning the handle clockwise (CW).
3. Pump the handle up and down several times.
4. Release the handle, and it will automatically return to position with the release valve closed.
5. Test the jack for normal operation. If the lift pad doesn't rise to the correct height, repeat Steps 2–4. If this doesn't solve the problem, call the OTC Technical Services Dept. at (800) 533-6127.

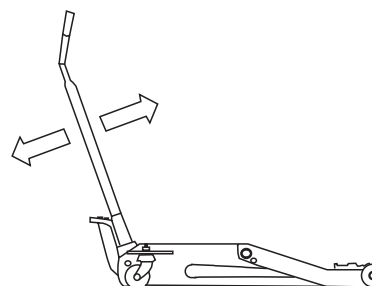
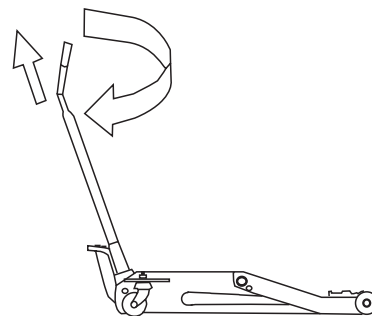

## Safety Precautions



**CAUTION:** To prevent personal injury and/or damage to equipment,

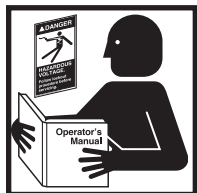

- Read, understand, and follow all instructions, including ASME PALD Part 10 for service jacks. If the operator cannot read these instructions, operating instructions and safety precautions must be read and discussed in the operator's native language.

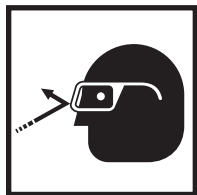

- Before using the service jack to lift a vehicle, refer to the vehicle service manual to determine recommended lifting surfaces on the vehicle chassis.
- Wear eye protection that meets ANSI Z87.1 and OSHA standards.
- Inspect the jack before each use; do not use the jack if it's damaged, altered, or in poor condition. Take corrective action if any of the following conditions are found: cracked or damaged housing; excessive wear, bending, or other damage; leaking hydraulic fluid; scored or damaged piston rod; loose hardware; modified or altered equipment.



- A load must never exceed the rated lifting capacity of the jack.
- Use the jack on a hard, level surface. The jack must be free to roll without any obstructions while lifting or lowering the vehicle. The wheels of the vehicle must be in the straight-ahead position and the hand brake released.
- Use the jack for lifting purposes only. Stay clear of a lifted load. Place support stands under the axles before working on the vehicle.
- Center the load on the jack saddle. Off-center loads can damage seals and cause jack failure. Lift only dead weight.
- Do not use blocks or other extenders between the saddle and the load being lifted.

- Do not modify the jack or use adapters unless approved or supplied by OTC.
- Lower the jack slowly and carefully while watching the position of the jack saddle.
- Use only approved hydraulic fluid. Never use brake fluid.

## Operating Instructions

### To Lift a Load

1. Position the jack under the vehicle.

**⚠ WARNING: To prevent personal injury and/or equipment damage,**

- Use the manufacturer's recommended lifting points on the chassis.
- Avoid wheel obstructions such as gravel, tools, or uneven expansion joints.

2. Pump the jack handle up and down, using the full stroke range of the piston, to raise the saddle to the contact point.
3. Check the placement of the jack; the load must be centered on the jack saddle.
4. Finish lifting the vehicle by pumping the handle. Do not attempt to raise the jack beyond its travel stops.
5. Place approved support stands under the vehicle at points that will provide stable support. Before making repairs on the vehicle, lower it onto the support stands by SLOWLY and CAREFULLY pulling on and turning the handle clockwise (CW).

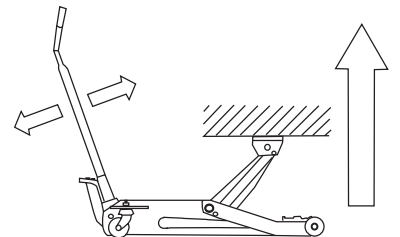

### To Lower a Load

Support stands should be holding the load during vehicle repairs. When ready to lower the load:

1. Follow steps 1-4 of the "To Lift a Load" section above.
2. Lift the load just enough to remove the support stands.
3. Pull on and turn the jack handle clockwise (CW). The load will lower smoothly and uniformly.
4. When the load and jack are completely lowered, release the handle. The handle will automatically return to its position for lifting.

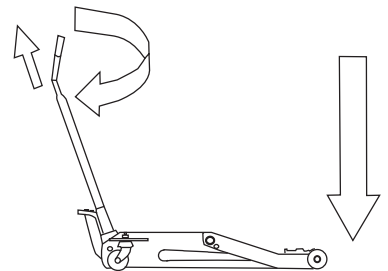

## Preventive Maintenance

**IMPORTANT: The greatest single cause of failure in hydraulic units is dirt.** Keep the service jack clean and well lubricated to prevent foreign matter from entering the system. If the jack has been exposed to rain, snow, sand, or grit, it must be cleaned before it is used.

1. Store the jack in a well-protected area where it will not be exposed to corrosive vapors, abrasive dust, or any other harmful elements.
2. Regularly lubricate the moving parts in the wheels, arm, handle, and pump roller pin.
3. Replace the hydraulic fluid in the reservoir at least once per year. To check the hydraulic fluid level, lower the lifting arm completely. Remove the rubber filler plug from the power unit. The hydraulic fluid level should be at the bottom of the filler plug hole. If necessary, add hydraulic fluid, and install the filler plug. **IMPORTANT: The use of alcohol or hydraulic brake fluid could damage the seals and result in jack failure.**
4. Inspect the jack before each use. Take corrective action if any of the following problems are found:
  - a. cracked, damaged housing
  - b. excessive wear, bending, other damage
  - c. leaking hydraulic fluid
  - d. scored, damaged piston rod
  - e. loose hardware
  - f. modified equipment
5. Keep warning labels and instructional decals clean and readable. Use a mild soap solution to wash external surfaces of the jack.

## Troubleshooting Guide

Repair procedures must be performed in a dirt-free environment by qualified personnel who are familiar with this equipment.

 **CAUTION: To prevent personal injury, all inspection, maintenance, and repair procedures must be performed when the jack is free of a load (not in use).**

Trouble	Cause	Solution
<b>Jack does not lift</b>	1. Release valve is open.	1. Verify the release valve is closed by position of the handle. Release valve may need cleaning.
	2. Low/no hydraulic fluid in reservoir.	2. Fill with approved hydraulic fluid and bleed system.
	3. Air-locked system.	3. Bleed system. (See "Bleeding Air from the system" on back of page 1.)
	4. Load is above capacity of jack.	4. Use correct equipment.
	5. Delivery valve and/or bypass valve not working correctly.	5. Clean to remove dirt or foreign matter. Replace hydraulic fluid.
	6. Packing worn out or defective.	6. Replace packing.
<b>Jack lifts only partially</b>	1. Too much or not enough hydraulic fluid.	1. Check hydraulic fluid level.
<b>Jack advances slowly</b>	1. Pump not working correctly.	1. Rework pump.
	2. Leaking seals.	2. Replace seals. (OTC Seal Kit No. 553743)
<b>Jack lifts load, but doesn't hold</b>	1. Cylinder packing is leaking.	1. Replace packing.
	2. Valve not working correctly (suction, delivery, release, or bypass).	2. Inspect valves. Replace if necessary.
	3. Air-locked system.	3. Bleed system.
<b>Jack leaks hydraulic fluid</b>	1. Worn or damaged seals.	1. Replace seals.
<b>Jack will not retract</b>	1. Release valve is closed.	1. Open the release valve by pulling on and turning the handle clockwise (CW). May be necessary to clean release valve.
<b>Jack retracts slowly</b>	1. Cylinder damaged internally.	1. Send jack to OTC-authorized service center. (Refer to OTC Form No. 104031.)
	2. Return spring(s) is damaged.	2. Replace return spring(s).
	3. Link section is binding.	3. Lubricate link sections.